



# Thermo Scientific PCR plastics selection guide

Superior quality for high-performance PCR



# Supporting great science through innovation in molecular biology

For over 25 years, the Thermo Scientific™ molecular biology portfolio has represented leading technology, reliable results, and superior service. Our innovations produced novel restriction enzymes, the highest-fidelity polymerases, and the most thermostable reverse transcriptases. Today, the people behind our expanding portfolio remain committed to supporting your research and making it even easier for you to do great science.

# Thermo Scientific PCR plastics

## Our passion—your results

- Designed, manufactured, and tested to ensure optimal PCR and qPCR performance
- White plastics optimized for qPCR
- Wide range of sealing options
- Standard and customized plate barcoding

## All PCR plastics are the same. Right? Wrong.

For over 25 years, we have been supplying a comprehensive range of high-quality consumables for molecular biology research. These trusted products represent a complete, state-of-the-art offering for molecular biology research.

Protect your entire PCR workflow by choosing Thermo Scientific™ plastics. Our PCR plastics are designed, manufactured, and tested to help ensure optimal PCR performance.

[thermofisher.com/thermoscientificplastics](https://thermofisher.com/thermoscientificplastics)

# Not all PCR plastics are created equal

## Contents

Choosing a plate	5
How our products are different	8
White plastics—optimized for qPCR	10
PCR sealing options	12–13
Individual tubes and strips	14–15
PCR plates	16–21

### 96-well

Skirted	Low profile	16
Skirted, robotic	Low profile	16
Semi-skirted	Fast block	17
	Flat deck	
	Raised deck	
	Segmented	
Non-skirted	Standard	18
	Low profile	

24- or 48-well	Semi-skirted	Standard	19
----------------	--------------	----------	----

### Ultrathin wall

Low-profile	24-well	18–19
	24-well white	
	96-well	
	96-well white	

### 384-well

Robotic	Armadillo	20
Standard	Standard	21
	Extra volume	

Selection guide: tubes and caps	22
Barcoding options	24

## Choosing a plate

Please refer to the following compatibility table to find the Thermo Scientific™ plate suitable for your instrument. Plate model recommendations are based on optimal PCR performance and ease of handling. Most recommended plates are either fully skirted or semi-skirted, as these plates offer increased rigidity, which reduces plate warping during thermal cycling, facilitates multichannel pipetting, and improves overall ease of use.

										Thermal cyclers							
Bio-Rad										Agilent (Stratagene)				Eppendorf			
PCR					qPCR					PCR		qPCR		PCR		qPCR	
MJ Mini	T100	iCycler, MyCycler	C1000, S1000	PTC-2(xx)	PTC-100 with 96-well block	iCycler	iQ4, iQ5, MyiQ, MyiQ2	CFX96, CFX384	Opticon	MiniOpticon	SureCycler 8800	RoboCycler Gradient 96	Mx4000	Mx3000P, Mx3005P	Mastercycler Gradient	Mastercycler ep Gradient, pro, nexus	Mastercycler ep realplex

### 96-well

Profile	Instrument	Model	MJ Mini	T100	iCycler, MyCycler	C1000, S1000	PTC-2(xx)	PTC-100 with 96-well block	iCycler	iQ4, iQ5, MyiQ, MyiQ2	CFX96, CFX384	Opticon	MiniOpticon	SureCycler 8800	RoboCycler Gradient 96	Mx4000	Mx3000P, Mx3005P	Mastercycler Gradient	Mastercycler ep Gradient, pro, nexus	Mastercycler ep realplex
Fully skirted	Low profile	AB-0800, AB-2800			●	●	●		●	●				●				●	●	●
Skirted, robotic	Low profile	AB-2396			●	●	●		●	●				●				●	●	●
Semi-skirted	Standard profile	AB-1400		●	●	●	●	●	●	●					●	●	●	●	●	●
Semi-skirted, segmented	Standard profile	AB-0900		●	●	●	●	●	●	●				●	●	●		●	●	●
Semi-skirted, robotic	Standard profile	AB-2596		●	●	●	●	●	●	●				●	●	●		●	●	●
	Low profile	AB-2496			●	●	●			●	●			●				●	●	●
Non-skirted	Standard profile	AB-0600	●	●	●	●	●	●	●	●				●	●	●		●	●	●
	Low profile	AB-0700	●		●	●	●			●	●	●	●	●	●	● <sup>1</sup>	● <sup>1</sup>	●	●	●

### 24- or 48-well

Semi-skirted	Standard profile	AB-0624, AB-0648	●	●	●	●	●	●	●	●				●	●	●		●	●	●
--------------	------------------	------------------	---	---	---	---	---	---	---	---	--	--	--	---	---	---	--	---	---	---

### Ultrathin wall

Low profile	24-well	SPL0240			●	●	●		●	●				●	●	●		●	●	●
	24-well, white	SPL0241							●	●					●	●				●
	96-well	SPL0960																		
	96-well, white	SPL0961																		

### 384-well

Robotic	Standard profile	AB-2384			●	●			●					●				●	●	
Standard	Standard profile	AB-1384			●	●			●					●				●	●	
Extra volume	Standard profile	AB-0937			●	●			●					●						

● Recommended plate ● Alternative option

1 Compatible with "Perfect Fit Frames" available from Agilent.

2 For MegaBACE 1000 instruments purchased before July 2000, use PCR CyclePlate, 96-well (Cat. No. AB-1243).

3 Plates compatible with fully skirted block only.



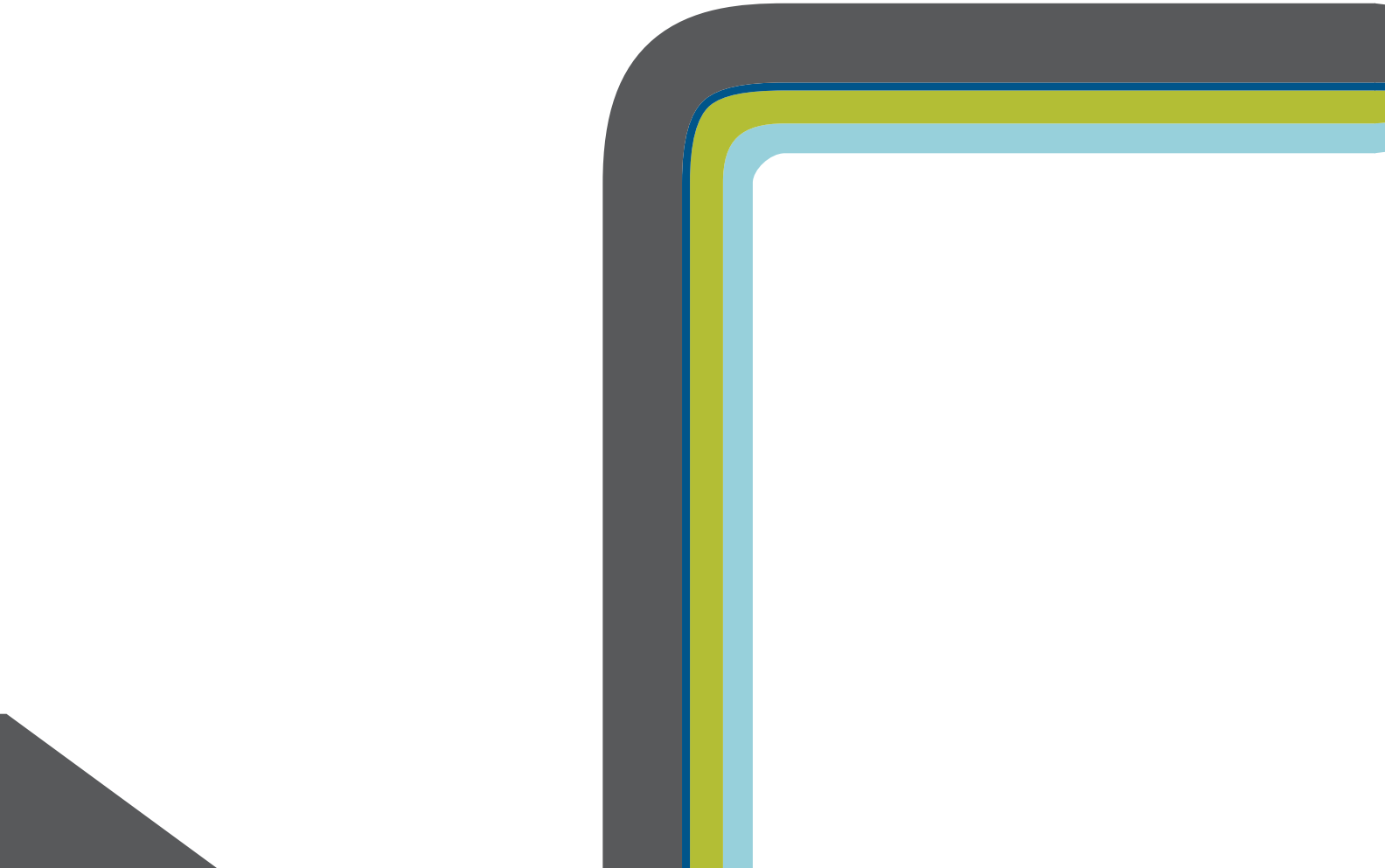

## Choose the right plate for your cycler

To help ensure proper fit and uniform heat transfer, we test each of our plate types across a broad range of PCR and qPCR cyclers and sequencers. Choose a plate that has been validated for use with your instrument block.

# Amplify with confidence

Our industry-leading manufacturing process does not include any shortcuts and is carried out in a world-class facility run by qualified experts. Our PCR plastics manufacturing facility is solely focused on the production of high-quality molecular grade plastics. Our team of engineers, molecular biologists, and QC/QA managers have the years of experience needed to help deliver reliable products that generate accurate and reproducible PCR data. Thermo Scientific™ PCR plastics are designed, manufactured, and tested to ensure PCR performance.

## PCR-focused manufacturing



### Cleanroom production

To avoid contaminants that can interfere with molecular biology applications, our entire production process, from molding to final packaging, is carried out in a Class 100,000 cleanroom under ISO 9001 guidelines. All of our PCR plastics are certified free from RNase, DNase, and human DNA.

In contrast, during typical non-cleanroom production, plastics are exposed to many contaminants including dust, bacterial cells, and DNA. The plastics are then sterilized to kill bacteria and inactivate RNases and DNases, but sterilization does not remove dust or DNA contamination. The dust particles left behind can inhibit PCR, and the damaged DNA fragments can still act as templates for nonspecific amplification.

### Medical-grade virgin polypropylene

The polymer we use is a select medical-grade polypropylene chosen for its exceptional biocompatibility. This polymer is inert and will not interfere with or adsorb PCR reaction components. To ensure purity, only virgin pellets are used—plastic waste from our manufacturing is recycled, but is not used in our products.

### Precision mold design and maintenance

Mold design and maintenance dramatically affect the quality of the PCR plastic—unpolished well surfaces can bind reaction components, and the presence of trace chemicals can inhibit amplification. Our tools are designed and maintained with this in mind, with no lubricants or releasing agents used in any part of the production process, and molds are cleaned and inspected after each production run.



The mold cavities are also extensively polished to produce ultrasmooth PCR well surfaces. This precision design and maintenance helps ensure our plastics are chemical-free and ultrasmooth to prevent PCR inhibition and maximize sample recovery.

## Unparalleled QC testing

### Integrity testing

Every well of every plate is visually inspected and tested using an electrostatic pinhole detection method. This thorough screening ensures every well is intact to protect all reactions.

### Evaporation testing

Samples from each lot are run through PCR cycling to test sealing performance. Well liquid volumes are analyzed post-PCR to verify seal integrity. This ensures every production lot conforms to strict tolerances.

### Biological testing

Samples from each batch are biologically tested to certify them free of RNase, DNase, and human DNA. Every package contains a PCR certificate for your convenience and documentation.





# Innovative product design

## High efficiency, reduced variability

Uniform, ultrathin walls deliver maximum and consistent heat transfer for equally high performance from every sample.

## Evaporation protection

Raised rim design around each well enables secure sealing and safeguards against evaporation.

## White plastics for enhanced qPCR detection

Thermo Scientific™ white qPCR plastics are designed to enable sensitive and accurate fluorescence detection by preventing refraction out of the tube and increasing the signal-to-noise ratio.

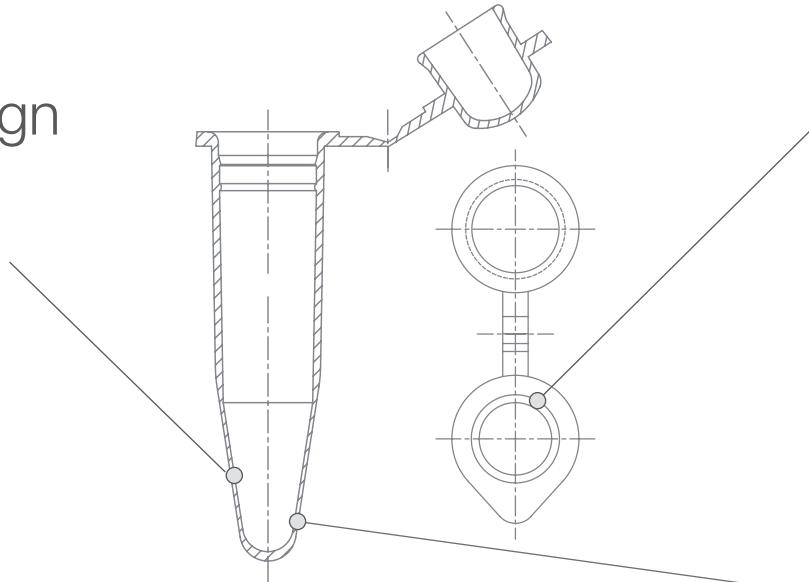

## Secure, easy sealing

Specially designed caps create a tight seal that is still easy to open and close. Strip tubes are available in individually attached cap versions.

## Ultrathin wall technology for fast PCR

Thermo Scientific™ ultrathin wall tubes and plates represent the new generation of PCR consumables, bringing significantly improved performance in fast PCR and qPCR assays. Each well wall is approximately 50% thinner than standard thin-walled tubes and plates. This further reduces the thermal barrier to heat flow into and out of the PCR sample, resulting in faster and more robust reactions.

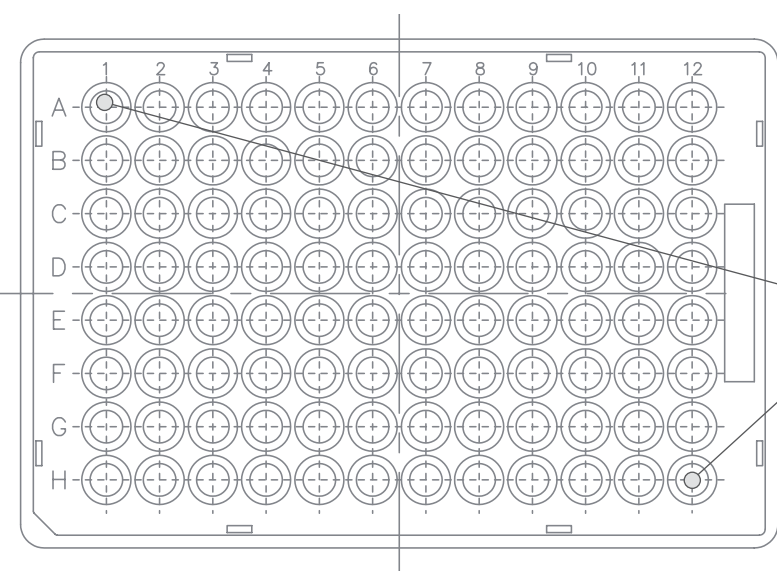
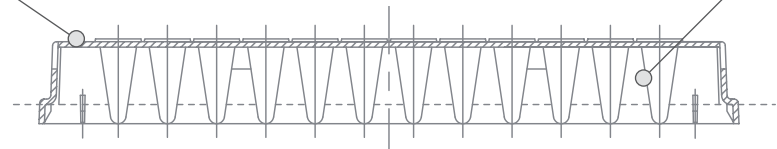

## Consistent results from A1 to H12

Reinforced plate decks and ultrarigid options prevent plate warping and keep heat transfer consistent across the entire plate.

# White plastics—optimized for qPCR

As with any fluorescence-based assay, qPCR requires specialized plastics to achieve optimal results. Thermo Scientific™ white qPCR plastics are designed to enable sensitive and accurate fluorescence detection. When used together with Thermo Scientific™ Ultra Clear caps or optical seals, these products will help increase sensitivity and reduce variability in your qPCR assay.

## Increased sensitivity for improved detection of low copy number targets

### White plates give maximum signal reflection

Our white plates reflect significantly more signal than traditional clear plates (Figure 1). The improved signal reflection ensures that even the lowest levels of fluorescence are detected (Figure 2).

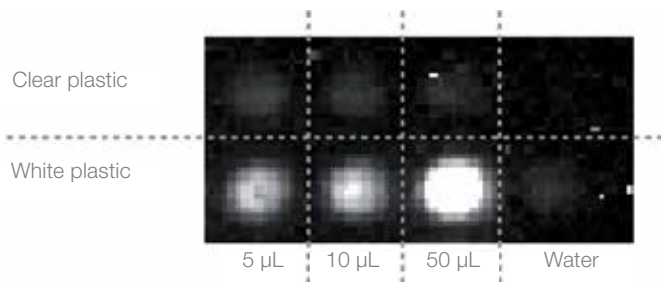

**Figure 1. White plates reflect significantly more signal than clear plates.** Three dilutions of fluorescein were added to either white or clear plates and detected using a CCD camera. White plastic reflects signal more effectively than clear plastic, resulting in a higher signal-to-noise ratio.

## Optical seals allow for maximum signal transmission

Our Thermo Scientific™ Absolute™ qPCR adhesive seal features a pressure-sensitive sealing design. This nontacky adhesive binds to the well rims only upon application of pressure. This creates a strong seal only where it is needed, and leaves well openings ultraclear for maximum fluorescence transmission.

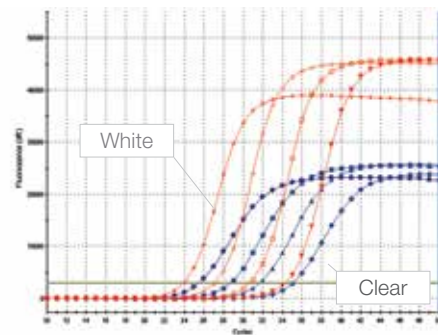
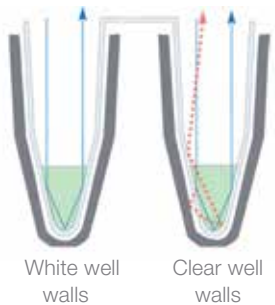

**Figure 2. Increased signal reflection leads to lower C<sub>t</sub> values.** qPCR amplification of GAPDH using 100 ng, 10 ng, 1 ng, and 100 pg of human genomic DNA. Red amplification plots representing the white plates show earlier C<sub>t</sub> values and higher endpoint fluorescence compared to the blue plots for the clear plates.

### Reduced variability for tighter technical replicates and improved reproducibility

#### White well walls enable consistent signal reflection

White well walls prevent signal from passing through to the cyclor block, where it can be inconsistently reflected or absorbed (Figure 3). This minimizes variations in the cyclor block that could affect your qPCR data (Figure 4).



**Figure 3. White well walls prevent signal refraction and absorption.** Clear well walls allow signal refraction through to the cyclor block, where it can be partially absorbed, introducing well-to-well variability. White well walls are nontransparent and isolate the signal to prevent signal loss.

### High-quality seal manufacture helps ensure consistent signal transmission and secure sealing

Thermo Scientific™ qPCR seals are precision manufactured for consistent seal thickness and transparency, resulting in equal signal transmission across the entire plate. The pressure-sensitive adhesive used creates a secure bond to minimize evaporation and maintain high PCR efficiency in each sample.

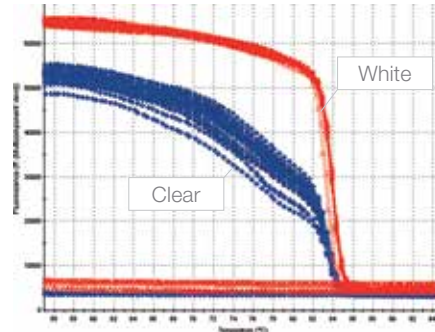

**Figure 4. Reduced well-to-well variability produces more consistent qPCR data.** Melting profiles of GAPDH amplicons in white plates (red) and clear plates (blue) are shown across four 10-fold dilutions of human genomic DNA. Signal refraction causes increased variability in clear plates.



# PCR plates



## Armadillo PCR plate, 96-well, skirted

- Thermo Scientific™ Armadillo™ PCR plates offer a polycarbonate skirt for warp-resistant thermal cycling—see page 21 for details
- Recommended for automated workflows
- Maximum well volume: 0.2 mL
- Cut corner: H1

### Ordering information

#### Armadillo PCR plate, 96-well

AB-2396	Clear	To select a frame color, please suffix the part number with /B for blue,
BC-2396	Clear with barcode	/G for green, /O for orange,
AB-3396	White	/R for red, or /Y for yellow
BC-3396	White with barcode	

Pack size: 25 plates



## PCR plate, 96-well, fully skirted, low profile

- ANSI footprint and stackable for use in automated systems
- Low profile to reduce dead space and increase PCR efficiency
- Available as Thermo Scientific™ SuperPlate™ version, providing 4x more rigidity for superior robotic handling
- Maximum well volume: 0.2 mL
- Cut corner: H1

### Ordering information

#### PCR plate, 96-well, fully skirted, low profile

AB-0800	Clear	AB-0800/B	Blue
AB-0800-L	Clear with black letters	AB-0800/G	Green
BC-0800	Clear with barcode	AB-0800/P	Purple
AB-0800/W	White	AB-0800/R	Red
AB-0800/W-L	White with black letters	AB-0800/Y	Yellow
BC-0800/W	White with barcode		

Pack size: 25 plates

#### SuperPlate PCR plate, 96-well, low profile

AB-2800	Clear	AB-2800/B	Blue
BC-2800	Clear with barcode	AB-2800/G	Green
AB-2800/W	White	AB-2800/P	Purple
BC-2800/W	White with barcode	AB-2800/R	Red
		AB-2800/Y	Yellow

Pack size: 25 plates



## Armadillo PCR plate, 96-well, semi-skirted, low profile

- Directly compatible with Roche Lightcycler 480 and Lightcycler 96 with no adapters necessary—see page 21 for details
- Low profile to reduce dead space and increase PCR efficiency
- Maximum well volume: 0.2 mL
- Cut corner: H12

### Ordering information

#### Armadillo PCR plate, 96-well, semi-skirted, low profile

AB-2496	Clear	To select a frame color, please suffix the part number with /B for blue,
AB-3496	White wells	/G for green, /O for orange,
BC-2496	Clear with barcode	/R for red, or /Y for yellow
BC-3496	White with barcode	

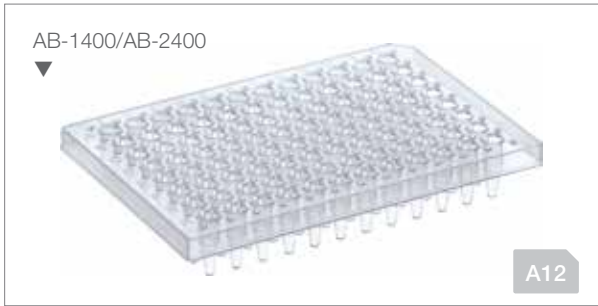

### PCR plate, 96-well, semi-skirted, flat deck

- Directly compatible with all standard platforms including sequencers with no adapters necessary
- Flat deck of plate facilitates sealing and handling
- Available as SuperPlate version, providing 4x rigidity for superior robotic handling
- Maximum well volume: 0.3 mL
- Cut corner: A12

#### Ordering information

##### PCR plate, 96-well, semi-skirted, flat deck

AB-1400	Clear	AB-1400/B	Blue
AB-1400-L	Clear with black letters	AB-1400/G	Green
BC-1400	Clear with barcode	AB-1400/P	Purple
AB-1400/W	White	AB-1400/R	Red
AB-1400/W-L	White with black letters	AB-1400/Y	Yellow
BC-1400/W	White with barcode	Pack size: 25 plates	

##### SuperPlate PCR plate, 96-well, semi-skirted, flat deck

AB-2400	Clear	AB-2400/B	Blue
BC-2400	Clear with barcode	AB-2400/G	Green
AB-2400/W	White	AB-2400/P	Purple
BC-2400/W	White with barcode	AB-2400/R	Red
		AB-2400/Y	Yellow
Pack size: 25 plates			



### Armadillo PCR plate, 96-well, semi-skirted

- Armadillo PCR plates offer a polycarbonate skirt for warp-resistant thermal cycling—see page 21 for details
- Recommended for automated workflows
- Maximum well volume: 0.3 mL
- Cut corner: A12

#### Ordering information

##### Armadillo PCR plate, 96-well, semi-skirted

AB-2596	Clear	To select a frame color, please suffix
AB-3596	White wells	the part number with /B for blue,
BC-2596	Clear with barcode	/G for green, /O for orange,
BC-3596	White with barcode	/R for red, or /Y for yellow
Pack size: 25 plates		



### PCR plate, 96-well, semi-skirted, segmented

- Proprietary segmented plate design allows plates to be cut into 24- and 48-well sections
- Semi-skirt adds rigidity and allows for labeling or barcoding
- Maximum well volume: 0.3 mL
- Cut corner: H1

#### Ordering information

##### PCR plate, 96-well, semi-skirted, segmented

AB-0900	Clear	AB-0900/B	Blue
BC-0900	Clear with barcode	AB-0900/G	Green
AB-0900/W	White	AB-0900/P	Purple
BC-0900/W	White with barcode	AB-0900/R	Red
		AB-0900/Y	Yellow
Pack size: 25 plates			



### PCR plate, 96-well, non-skirted, low profile

- Low profile to reduce dead space and increase PCR efficiency
- Available with black alphanumeric lettering
- Maximum well volume: 0.2 mL
- Cut corner: H12

#### Ordering information

##### PCR plate, 96-well, non-skirted, low profile

AB-0700	Clear	AB-0700/B	Blue
AB-0700-L	Clear with black letters	AB-0700/G	Green
AB-0700/W	White 	AB-0700/P	Purple
		AB-0700/R	Red
		AB-0700/Y	Yellow

Pack size: 25 plates



### PCR plate, 96-well, non-skirted, standard

- Non-skirted format compatible with most thermal cyclers
- Available with black alphanumeric lettering
- Maximum well volume: 0.3 mL
- Cut corner: H1

#### Ordering information

##### PCR plate, 96-well, non-skirted, standard

AB-0600	Clear	AB-0600/B	Blue
AB-0600-L	Clear with black letters	AB-0600/G	Green
AB-0600/W	White 	AB-0600/P	Purple 
AB-0600/W-L	White with black letters	AB-0600/R	Red
		AB-0600/Y	Yellow



Pack size: 25 plates



### Piko 96-well PCR plates and frames

- Ultrathin wall for fast PCR and qPCR applications
- Low profile
- Designed for use with Thermo Scientific™ Piko™ and PikoReal™ 96-well thermal cyclers
- Plates can be snapped into plate frame to create a standard 384-well plate
- Compatible with standard multichannel pipettes and liquid handling platforms
- Well spacing and footprint conform to industry (ANSI) dimensions
- Maximum well volume: 40 µL

#### Ordering information

<b>Piko 96-well PCR plate</b>	
SPL0960	Clear 
SPL0961	White 

Pack size: 200 plates

<b>Piko 96-well PCR frame</b>	
SFR0961	White

Pack size: 50 frames, only available in white

SFR0241, SPL0240



### Piko 24-well PCR plates and frames

- Ultrathin wall for fast PCR and qPCR applications
- Low profile
- Designed for use with Piko and PikoReal 24-well thermal cyclers
- Plates can be snapped into plate frame to create a standard 96-well plate
- Compatible with standard multichannel pipettes and liquid handling platforms
- Well spacing and footprint conform to industry (ANSI) dimensions
- Maximum well volume: 0.2 mL

#### Ordering information

##### Piko 24-well PCR plate

SPL0240 Clear

SPL0241 White

Pack size: 200 plates

##### Piko 24-well PCR frame

SFR0241 White

Pack size: 50 frames

AB-0624/AB-0648



### PCR plate, 24- and 48-well, semi-skirted, segmented

- Conveniently precut into 24- or 48-well segments
- Semi-skirt adds rigidity and allows for labeling or barcoding
- Maximum well volume: 0.3 mL

#### Ordering information

##### PCR plate, 24-well, semi-skirted

AB-0624 Clear

AB-0624/W White

Pack size: 50 plates

##### PCR plate, 48-well, semi-skirted

AB-0648 Clear

AB-0648/W White

Pack size: 50 plates

AB-1800/AB-1800W



### VersiPlate PCR Strip Tube Plate, 96-well, low profile

- Strip of eight tubes linked to each other forming the familiar 12 x 8 or 96-well ANSI format.
- Tear points between strips enable single or multiple strip requirements for customized experiments
- Maximum fill volume of 0.2 mL

#### Ordering information

##### VersiPlate PCR Strip Tube Plate, 96-well, low profile

AB-1800 Clear

AB-1800/W White

Pack size: 25 plates

##### VersiPlate Frame, 96-well, skirted

AB-1805 White

Pack size: 25 frames



**Armadillo PCR plate, 384-well**

- Armadillo PCR plates offer a polycarbonate skirt for warp-resistant thermal cycling—see page 21 for details
- Recommended for automated workflows
- Maximum well volume: 40 µL
- Cut corner: A24

**Ordering information**

**Armadillo PCR plate, 384-well**

AB-2384	Clear	To select a frame color, please suffix the part number with /B for blue, /G for green, /O for orange, /R for red, or /Y for yellow
BC-2384	Clear with barcode	
AB-3384	White	
BC-3384	White with barcode	

Pack size: 50 plates



**PCR plate, 384-well, fully skirted, standard**

- Fully skirted for use with automated systems
- Compatible with all leading 384-well block thermal cyclers
- Maximum well volume: 40 µL
- Cut corner: A24

**Ordering information**

**PCR plate, 384-well, fully skirted, standard**

AB-1384	Clear	AB-1384/B	Blue
BC-1384	Clear with barcode	AB-1384/G	Green
AB-1384/W	White	AB-1384/P	Purple
BC-1384/W	White with barcode	AB-1384/R	Red
		AB-1384/Y	Yellow

Pack size: 50 plates



**PCR plate, 384-well, fully skirted, raised chimney**

- Raised chimney design for extra volume
- Increased well volume accommodates sequencing and wash steps
- Maximum well volume: 55 µL
- Cut corner: A24

**Ordering information**

**PCR plate, 384-well, fully skirted, raised chimney**

AB-0937	Clear
---------	-------

Pack size: 100 plates





## The ultimate plate for high-throughput PCR and automated handling

Armadillo PCR plates combine the rigidity of a polycarbonate frame with thin-walled polypropylene wells to provide superior thermal cycling performance under all conditions without warping. Armadillo plates are available in 96- and 384-well formats in multiple colors. They can be ordered with a standard 128 barcode or custom barcoding. The specially designed warp-resistant frame and multiple format options make Armadillo PCR plates the ultimate choice for high-throughput and automated handling.

- Polycarbonate frame for warp-resistant thermal cycling
- Enhanced mechanical stability for robotic handling
- Thin-walled wells for optimal heat transfer
- Optimized well shape for maximum sample recovery
- Flat alphanumeric lettering and raised-rim well design for improved heat sealing
- Optically clear deck allows for easy visibility of wells
- Multiple frame color options, all available in both clear (for PCR) and white colored wells (for qPCR)

To find out more, visit [thermofisher.com/armadillo](https://www.thermofisher.com/armadillo)

# Barcoding options

## Add reliable tracking to your PCR workflow

Streamline your sample tracking with barcoded PCR plates. All Thermo Scientific™ fully skirted and semi-skirted PCR plates are available with random, off-the-shelf barcoding or custom barcoding for complete flexibility. All of our barcodes are designed to deliver reliable reading performance and durability for secure and efficient tracking.

Barcode labels are scratch-resistant and are able to withstand chemical exposures and wide temperature extremes from  $-196^{\circ}\text{C}$  to  $120^{\circ}\text{C}$ .

### Off-the-shelf barcoded plates

Our off-the-shelf barcoded plates can be ordered immediately, and are available for each fully skirted or semi-skirted PCR plate model. The standard Code 128 barcode has been carefully designed and positioned for compatibility

with all major barcode readers. Codes are random and each barcode also includes a human-readable format as a backup to help ensure valuable samples can always be identified.

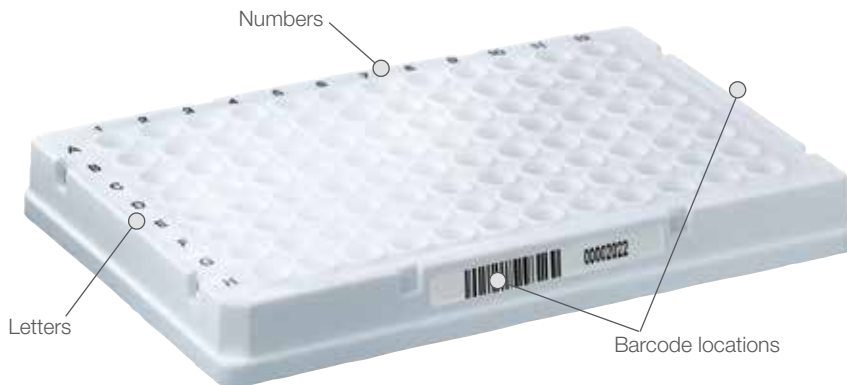

### Choose Thermo Scientific™ barcodes

- Wide temperature tolerance ( $-196^{\circ}\text{C}$  to  $120^{\circ}\text{C}$ )
- Proprietary coating for superior scratch resistance
- Precise sizing and placement for reliable scanning

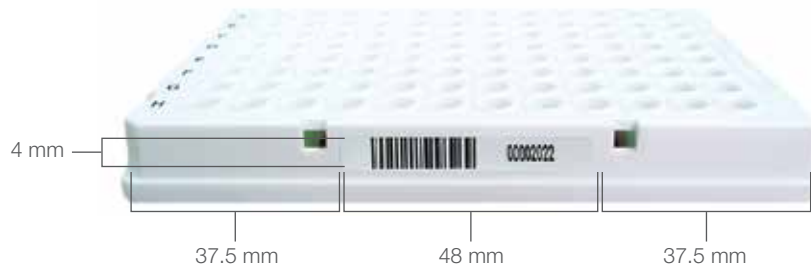

### Custom barcoding services









Do you have specific requirements not met by our off-the-shelf Code 128 barcoded plates? Our custom barcode services are flexible enough to meet your unique tracking specifications. These services utilize our durable barcodes and apply them in your preferred configuration or format, with any sequence, on any plate. Let us solve your tracking needs with our wide range of options.

### Design the perfect barcoding solution to fit your unique needs

Choose Thermo Scientific plates for the ultimate in barcoding flexibility:

- **Plate type**—any fully skirted or semi-skirted plate from the entire range of PCR plates
- **Barcode format**—Code 128, Code 39, or Interleaved 2 of 5, with flexible human-readable code position
- **Label size**—available in standard label sizes or customizable according to requirements
- **Barcode density**—range of dimensions available
- **Sequence**—you determine start-to-end sequence and alphanumeric pattern
- **Positioning**—any code on any side, all the same code or varied

### Barcode format options

		Barcode type		
		Code 128	Code 39	Code Interleaved 2 of 5
x-dimension	7 mils	A0000002 	A0000002 	0000001 
	10 mils	A0000002 	A00002 	0000001 
	13 mils	A0000002 	A002 	0000001 

### Minimum order requirements

1,000-plate minimum orders. Smaller quantities may be possible, but are subject to an additional fee. Please inquire.

To order your barcoding solution today, visit [thermofisher.com/custombarcodes](https://www.thermofisher.com/custombarcodes)

# Thermo Scientific PCR plastics selection guide for individual tubes, strip tubes, and caps by thermal cycler

Tube format	Type of cap	Tubes	Caps	Bio-Rad										Agilent (Stratagene)							
				T100, MJ Mini	iCycler, MyCycler	C1000, S1000	PTC-2(xx)	PTC-100 with 96-well block	iCycler	iQ4, iQ5, MyiQ, MyiQ2	CFX96	Opticon	MiniOpticon	SureCycler 8800	Gradient Cycler	Mx4000	Mx3000P, Mx3005P				
Standard profile 0.2 mL individual tubes	Flat	AB-0620	NA	—	—	—	—	—										—			
Standard profile 0.5 mL individual tubes	Flat	AB-0350	NA																		
Standard profile 0.2 mL strip tubes	Flat	AB-1182	NA	—	—	—	—	—										—			
	Ultra Clear	AB-1183	NA	●	●	●	●	●	●	●								●	●	●	
	Ultra Clear	AB-1191	NA							●	●								●	●	
	Ultra Clear	AB-1502	NA	●	●	●				●	●							●	●	●	
	Ultra Clear	AB-1502/W	NA							●	●								●	●	
Low profile 0.1 mL individual tubes	Ultra Clear	TUC0010	NA			●						●	●	●							
	Ultra Clear	TUC0011	NA									●	●	●							
Low profile 0.2 mL strip tubes	Flat	AB-0776	NA	—		—	—	—										—	—		
	Ultra Clear	AB-1770	NA	●		●	●	●		●		●	●	●				●	●		
	Ultra Clear	AB-1771	NA							●		●	●	●							
VersiPlate	Flat	AB-1800	AB-1815	—	—	—	—	—										—	—		
	Ultra Clear		AB-1820							●		●	●	●							
	Ultra Clear	AB-1800/W	AB-1820							●		●	●	●							

## Key

—	Flat cap
●	Ultra Clear
■	Recommended
■	Acceptable

Eppendorf			Biometra			Bibby Scientific (Techne)			Gene Technologies			MWG-Biotech			Takara			Thermo Scientific		
Mastercycler Gradient			T1 Thermocycler			Flexigene, TC-412, TC-4000			GS1, GS4, GSX			PCR Express, Px2, PxE			MultiBlock Satellite (MBS) System					
Mastercycler ep Gradient, pro, nexus			TGradient			Genius, Touchgene, TC-512, TC-5000			Primus 96			MultiBlock Satellite (MBS) System			Piko 24					
Mastercycler ep realplex			TRobot			TC-PLUS, Prime, PrimeG, Prime Elite			THEQ Lifecycler			MultiBlock Satellite (MBS) System			Arktik					
			TProfessional						TP 3000			Piko 24			PikoReal 24					
			TOptical									PCR Express, Px2, PxE								
												MultiBlock Satellite (MBS) System								
												Piko 24								
												Arktik								
												PikoReal 24								



# Individual tubes and strips

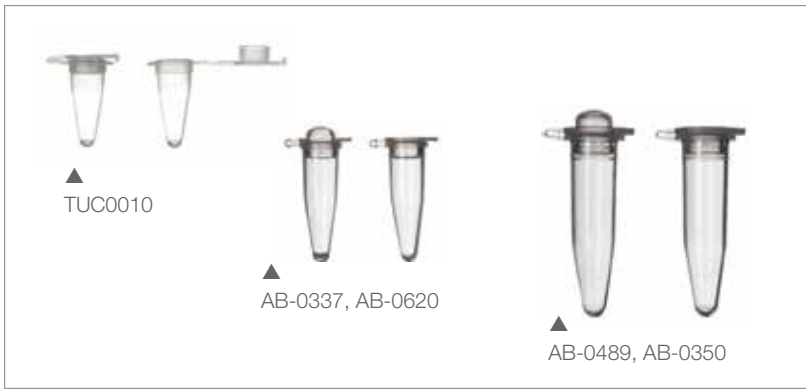

## Individual tubes

- Compatible with standard 0.2 mL or 0.5 mL thermal cycler blocks
- Ultrathin wall (UTW) and low profile for fast PCR applications
- Caps form a secure seal, yet are easy to open and close
- Also available in assorted colors

## Ordering information

### 0.1 mL individual tubes

TUC0010 UTW with flat caps	Clear	qPCR
TUC0011 UTW with flat caps	White	qPCR

Pack size: 960 tubes

### 0.2 mL individual tubes

AB-0620 Flat caps	Clear
AB-0622 Flat caps	Various colors
AB-0337 Domed caps	Clear
AB-0491 Domed caps	Various colors

Pack size: 1,000 tubes

### 0.5 mL individual tubes

AB-0350 Flat caps	Clear
AB-0533 Flat caps	Various colors
AB-0489 Domed caps	Clear
AB-0535 Domed caps	Various colors

Pack size: 1,000 tubes

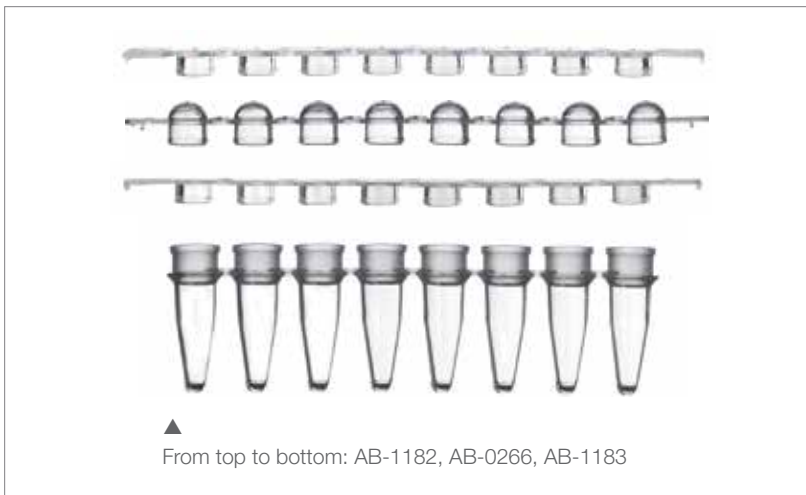

▲ From top to bottom: AB-1182, AB-0266, AB-1183

## 0.2 mL strip tubes

- Compatible with 0.2 mL thermal cycler blocks
- Ultra Clear cap options ideal for use in qPCR assays
- Caps form a secure seal, yet are easy to apply and remove
- 8 tubes per strip

## Ordering information

### 0.2 mL strip tubes

AB-1182 Flat caps	Clear
AB-0496 Flat caps	Various colors

Pack size: 250 tube strips/cap strips

AB-0266 Domed caps	Clear
AB-0490 Domed caps	Various colors

Pack size: 250 tube strips/cap strips

AB-1183 Ultra Clear caps	Clear	qPCR
AB-1191 Ultra Clear caps	White	qPCR

Pack size: 120 tube strips/cap strips

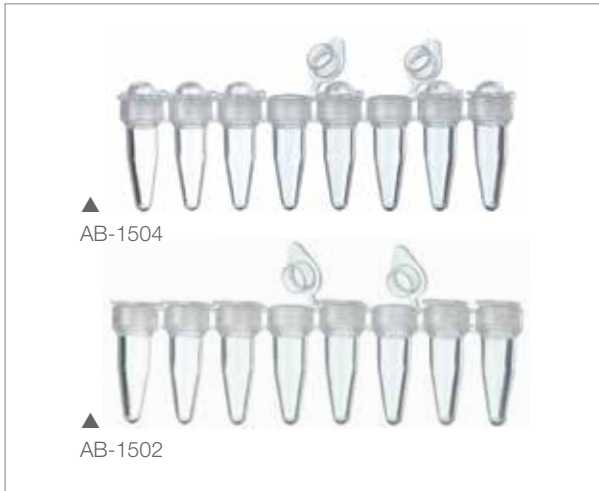



### EasyStrip tubes

- PCR strip tubes with individually attached caps for easy sample access
- Compatible with 0.2 mL thermal cycler blocks
- Ultra Clear cap options ideal for use in qPCR assays

#### Ordering information

##### EasyStrip Snap Tubes

AB-1504	Domed caps	Clear
AB-1502	Ultra Clear caps	Clear 
AB-1502/W	Ultra Clear caps	White 

Pack size: 250 strips.

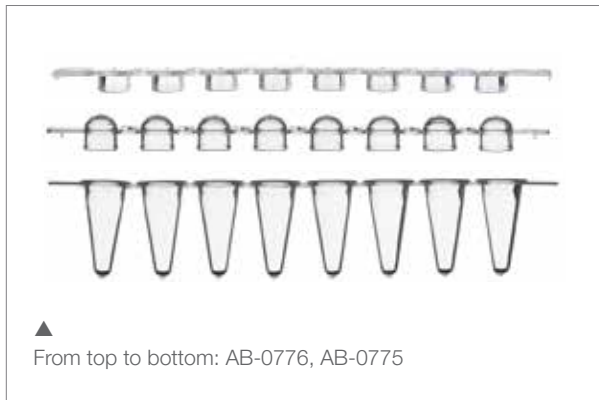



### Low-profile strip tubes

- Ideal for reaction volumes below 20  $\mu$ L
- Compatible with 0.2 mL thermal cycler blocks
- Low profile to reduce dead space and increase PCR efficiency
- Labelled A–H end tabs

#### Ordering information

##### Low-profile strip tubes

AB-0776	Flat caps	Clear	AB-0777	Domed caps	Various colors
AB-0778	Flat caps	Various colors	AB-1770	Ultra Clear caps	Clear 
AB-0775	Domed caps	Clear	AB-1771	Ultra Clear caps	White 

Pack size: 250 tube strips/cap strips

## VersiCap Mats—efficient and environmentally friendly sealing solution

Thermo Scientific™ VersiCap™ Mats are versatile seals compatible with 96-well PCR plates as well as 8-tube PCR strips. VersiCap Mats are designed so that strips of eight caps are linked to one another with small tear points. This allows easy separation of the exact number of cap strips required for an experiment, which helps to reduce plastic waste. When sealing plates, multiple cap strips can be applied at the same time, resulting in shorter PCR setup time and simplified overall workflows.

Learn more at [thermofisher.com/thermoscientificplastics](https://www.thermofisher.com/thermoscientificplastics)

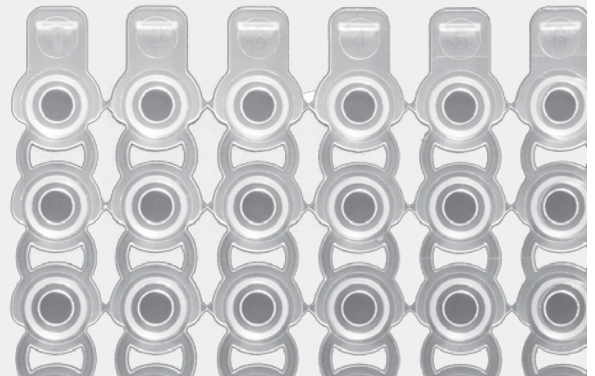

# PCR sealing options

We offer a wide range of robust sealing options to suit any application. All our sealing products are designed to provide the ultimate in sample protection while also being easy to use. Thermo Scientific™ qPCR sealing options are optically clear to enable maximum and consistent signal transmission, critical for accurate qPCR results.

- Successfully tested
- ✗ Not recommended

		PCR cap strips					
		Flat cap strips <sup>2</sup>	Domed <sup>2</sup> cap strips	Ultra Clear qPCR cap strips	Ultra Clear flat cap strips for UTW <sup>3</sup> plates	Flat cap VersiCap Mats <sup>2</sup>	Ultra Clear VersiCap Mats
	<b>Cat. No.</b>	AB-0784 (8 caps per strip)	AB-0265 (8 caps per strip)	AB-0866 (8 caps per strip)	TCS-1080 (8 caps per strip)	AB-1815 (12 x 8 strips)	AB-1820 (12 x 8 strips)
	<b>Pack size</b>	250 strips	250 strips	120 strips	120 strips	25 mats	25 mats
<b>Applications</b>	PCR (including water bath)	●	●	●	●	●	●
	qPCR	✗	✗	●	●	✗	●
	Sealing temp. range	-20°C to 120°C	-20°C to 120°C	-20°C to 120°C	-20°C to 120°C	-20°C to 120°C	-20°C to 120°C
	Long-term storage	●	●	●	●	●	●
<b>Mechanical properties</b>	Pierceable	✗	✗	✗	✗	✗	✗
	Peelable	●	●	●	●	●	●
	Resealable	●	●	●	●	●	●
	Thickness <sup>1</sup>						
<b>Resistance</b>	DMSO (100%)	●	●	●	●	●	●
	Ethanol (100%)	●	●	●	●	●	●
	Isopropanol (100%)	●	●	●	●	●	●
	UV irradiation	●	●	●	●	●	●
	Gamma irradiation	●	●	●	●	●	●
<b>Compatible products</b>	Applicator tools	AB-0536	AB-0536	AB-0536			
	Tubes/plates	8-strip PCR tubes 96-well PCR plates	8-strip PCR tubes 96-well PCR plates	8-strip PCR tubes 96-well PCR plates	SPL0240 SPL0241	8-strip PCR tubes 96-well PCR plates	8-strip PCR tubes 96-well PCR plates



1. Does not include release liner.  
 2. Choose cap shape according to the instrument manufacturer's recommendation.  
 3. Ultrathin wall.



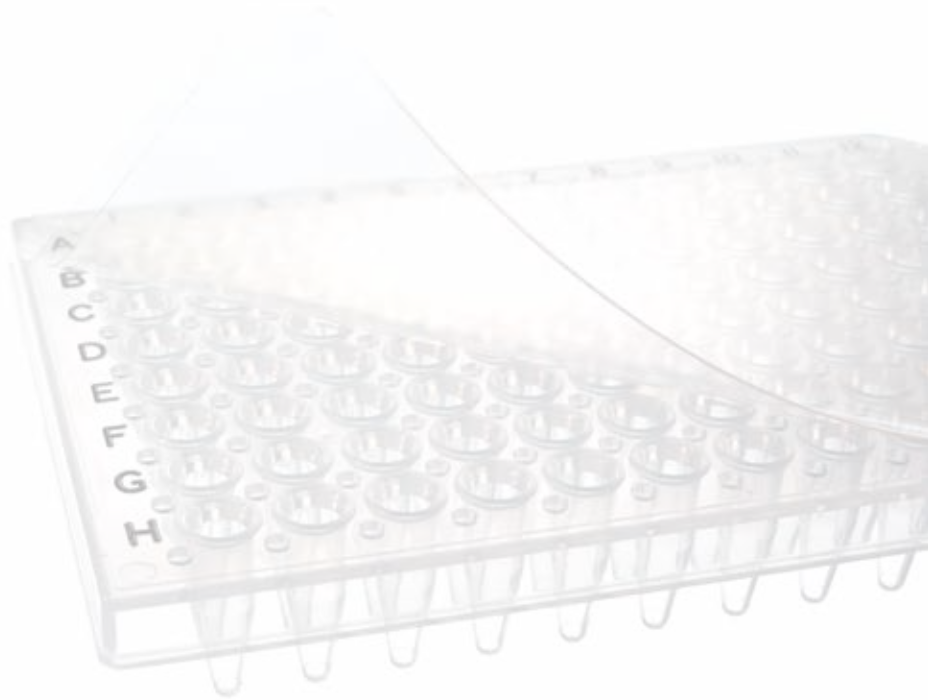
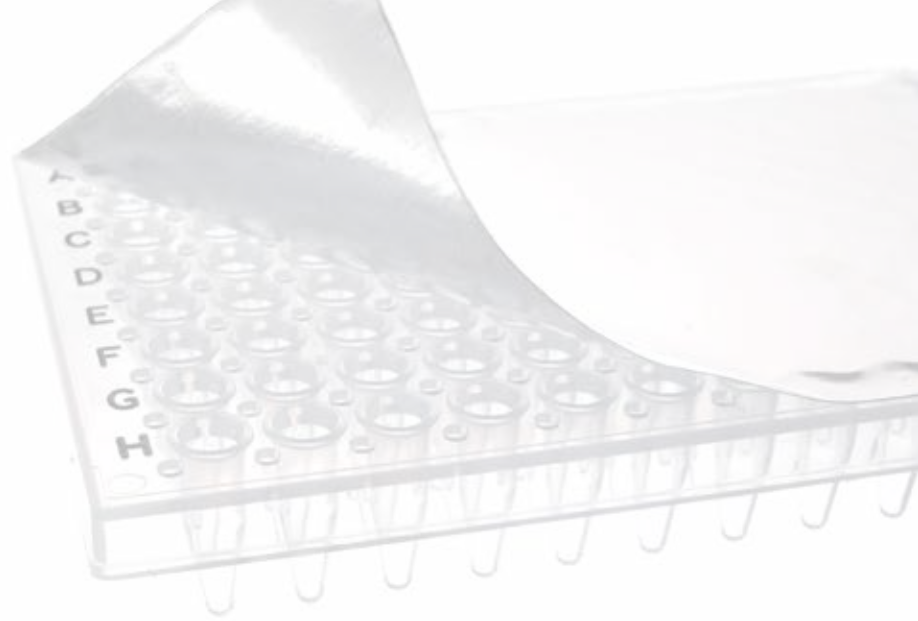

### Adhesive seals

PCR foil seal	PCR film seal	Piko PCR/qPCR film seal	ABsolute qPCR seal
AB-0626	AB-0558	ASF-0020	AB-1170
100 sheets	100 sheets	400 sheets	50 sheets

●	●	●	●
×	×	●	●
-40°C to 120°C	-20°C to 120°C	-20°C to 120°C	-80°C to 110°C
●	●	×	×

8.1 N force	×	×	×
●	●	●	●
●	●		
75 µm	255 µm	255 µm	100 µm

●	×	×	●
×	×	×	●
×	×	×	●

AB-1391	AB-1391	AB-1391	AB-1391
All plates	All plates	SPL0240 SPL0241 SPL0960 SPL0961	All plates

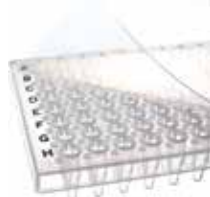

To learn more about all of your PCR plastics needs, go to  
[thermofisher.com/thermoscientificplastics](http://thermofisher.com/thermoscientificplastics)



**Austria:** +43 (0)800 20 88 40 **Belgium:** +32 (0)056 260 260 **Denmark:** +45 70 27 99 20  
**Germany:** +49 2304 932-5 **Ireland:** +353 (0)1 885 5854 **Italy:** +39 02 950 59 478  
**Finland:** +358 (0)9 8027 6280 **France:** +33 (0)3 88 67 14 14 **Netherlands:** +31 (0)20 487 70 00  
**Norway:** +47 22 95 59 59 **Portugal:** +351 21 425 33 50 **Spain:** +34 902 239 303  
**Sweden:** +46 31 352 32 00 **Switzerland:** +41 (0)56 618 41 11 **UK:** +44 (0)1509 555 500